

ITALIAN EXCELLENCE IN AUTOMATION & ENERGY

Electronic systems, Motors, Alternators
in standard and extra-ordinary execution



sps ipc drives

**GROUP MAGAZINE
SPECIAL EDITION
SPS IPC DRIVES
NÜRNBERG 2017**

Italian Group, Italian Quality



A BRAND OF
soga



energyteam

AUTOMATION & ENERGY UNDER ONE GROUP, SPREADING ITALIAN BEST KNOW-HOW

CMZ IS AN **ITALIAN COMPANY** SPECIALIZED IN **MOTION CONTROL** SINCE 1976 BY PROVIDING ELECTRONIC SYSTEMS, HARDWARE PRODUCTS AND SOFTWARE SOLUTIONS.

ITS MAIN ASSET IS R&D, STRONGLY FOCUSED IN DEVELOPING A GLOBAL RANGE OF **HIGH-TECH SPECIAL PROJECTS FOR OEMs**.

CMZ IS PART OF THE SOGA ENERGY TEAM INDUSTRIAL GROUP, MANUFACTURER OF ELECTRIC MOTORS AND GENERATORS SINCE 1966, KNOWN IN 80 COUNTRIES THANKS TO ITS BRANDS.

THE GROUP'S CORE SKILL IS THE COMBINED OFFERING OF STANDARD AND CUSTOM EXECUTIONS, SPREADING **ITALIAN EXCELLENCE** IN THE MOST DIFFERENT MARKETS AND APPLICATIONS.

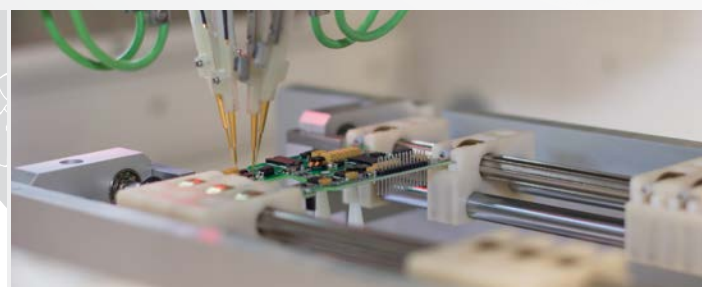



AUTOMATION



Electronic systems

ENERGY



Electric motors



Alternators and welders



PTO generators



Generators for special projects

Enrico Soga
CEO of the Soga
Energy Team since
2010, leading the
corporate event for
the 50 years of the
group 1966-2016



«ENERGY & AUTOMATION TOGETHER. CAN YOU IMAGINE WHAT THIS CAN BRING TO? I SEE JUST ONE THING: A FUTURE OF EXCELLENCE»

Interview to Enrico Soga, CEO of the Soga Energy Team,
describing the recent acquisition of CMZ and the Group's business approach.

1) CMZ is part of the Soga Energy Team since this year (2017, July). How would you describe this new adventure?

«Like a contribution to *Innovation*. Soga Energy Team is a multi-brand industrial group always focused on finding technical solutions for worldwide OEMs.

Thanks to the new synergy with CMZ company, it will be possible to mix our electromechanical know-how in the Energy

sector with CMZ's high-tech skills in the Automation. These are some of the contemporary most important industries and now we are connecting them under one Group, with shared values and the same business approach. Can you imagine what this can bring to?

We will extend our Group's overall offering to new, complementary and different applications. We'll develop new connections in our product ranges while giving our clients an even greater choice and even more solutions. I see just one thing: a future of excellence».

2) You promote your "Italian excellence": what is such a statement based on?

«Our Italian excellence is in our R&D's skills to develop motors, alternators, electronic systems engineered upon on-demand specifications, with high technology inside and made by using the most modern production equipment. Excellence is in our expertise, dating back to 1966 for energy and 1976 for automation, in developing special projects and custom products for OEMs, besides our range of standard products.



In the energy sector, with Soga division we manufacture electric motors supplying for instance the auxiliary units on high speed trains worldwide. Today, we are included amongst those companies who are the Suppliers of Excellence for the world's most advanced trains.

With Sogaenergies division we are leaders in Italy in the production of direct-drive PMGs for wind turbines.

In the automation sector, CMZ is leader in Italy in solutions for motion control. The core of CMZ is the R&D dept with a team of specialized engineers. This company has been one of the first companies in the world in developing the stepless technology to control the motors in continuous mode by modular current, eliminating the loss of the step and significantly reducing the motors temperature. Moreover, CMZ is certified as a Research Laboratory authorized by the Italian Ministry for Scientific Research, and it avails of co-operations with University of Padua, recognized for its authority all over the world. Further, CMZ range IBD of brushless motors with integrated drives is one of the widest today available in the market».

3) Your approach to the market: do you follow or drive the trends?

«We are always pioneers. We do not pursue the market: we choose it and create it. We act independently. We're not interested on making all what our competitors do, nor relying on quantities and numbers alone. Since my father Lino Soga founded the company in 1966 (Soga S.p.A, editor's note), we have always been working on continuous innovation and testing with R&D, on the range diversification, as well as on strong personal relationships with customers.

Such an attitude makes us different and on this basis we have always been developing significant technical innovations advancing the whole industry of rotating electrical machines, from the introduction in the power generation market of the first pto tractor-driven generators in 2001, to the welders with battery charger and jump-starter launched in 2012, to the variable speed solutions which we are working at since 2008».

4) As an industrial group with strong values and a family-driven ethos, is it possible to remain true to yourself in the current market?

«The Soga Energy Team is a group made of 3 companies (Soga S.p.A and CMZ Sistemi Elettronici S.r.l in Italy, Sincro d.o.o in Croatia), 6 plants and a direct staff of 300 people plus the indirect employees: men and women that every day make my family's entrepreneurial project a reality.

We have a business model heavily centered on our values, on which we have built our company. Our focus is the quality of our presence in the market.

OEMs who choose the Soga Energy Team are aware that they can get far more from us than our rotating electrical machines and electronic systems. With us, they can count on a flexible team ready to support them in every need, whether it is dealing with the co-creation of a new product, its production or any after-sale issue.

Our internal organization reveals ideal encouraging direct and fast decision-making processes, where relationships are based on the importance of people.

My family and I hold the top roles in the group, and the other key roles are given to trustworthy managers and collaborators. This mix of skills triggers continuous improvement within our group».

5) Future directions: how far do you aim to get?

«Our vision is clear. We'll keep following alternative ways, whilst maintaining our values, to build up more and more our market positioning as protagonists within industries demanding electric motors, generators and electronic systems designed with a different approach, innovative because unconventional.

Our will and passion are stronger than ever. Being innovators means to dare to act upstream, to always meet the market with new answers».





MASTER CONTROLLERS



BRUSHLESS DRIVES & MOTORS



STEPLESS DRIVES & MOTORS



PERIPHERALS



HMI: INDUSTRIAL TOUCH PANELS



SOLUTIONS

READY FOR INDUSTRY 4.0 AUTOMATION IS ALSO MADE IN ITALY



What makes Italy famous in the world? It is common sense answering: the 3 "Fs"! Food, Fashion, Furniture.

Italy is one of the main successful players in international markets also when talking about automation, technology, machines and industrial equipment, even if in these fields quality and innovation are often connected to other countries.

CMZ Sistemi Elettronici is determined in competing with multinational companies, distinguishing for these features:

- High technology
- Customization
- Complete range
- Application expertise.

CMZ has been operating in industrial automation since 1976 as manufacturer of electronic equipment, generally with microprocessor. Its 70 collaborators are strongly concentrated in hardware and software development, followed by sales, customer care, production.

The company is active in Italy and many foreign countries (including France, Spain, Turkey, India) thanks to its distributors and service network.

CMZ solutions extend to a variety of different applications by offering custom projects and products (according to the customer's needs) as well as standard products developed and produced internally.

Most of CMZ success is based on the research and development of on-demand special solutions for OEMs. This is why the company is certified as a Research Laboratory since 1992.

Standard products, which in the past were mainly represented by PLCs oriented to the motion control programmable through common automation languages, are today available in a complete range for any kind of configuration, fully in accordance with customers' requirements.

Besides axis controllers with integrated PLC, other products are: terminals, drives, stepper and brushless motors in integrated version or stand alone, I/O modules.

CMZ offers its customers a complete service which includes the complete application development, up to personalized or group training courses.

In more than 40 years of experience, CMZ has been gaining specific competences:

- Development and production of all kinds of boards with microprocessor, from the microcontroller to high frequency processors and software for the management of the boards
- Base and applicative programmes
- Operating systems, integration of standard operating systems, communication protocols etc.
- Integrated and stand alone drives for stepper and brushless motors
- Touch screen terminals
- Fieldbus (CANopen, EtherCAT, Profibus-DP, Ethernet-IP, etc)
- Data transmission and acquisition, weight control, different softwares (kinematics, regulation, analysis and protocols)
- Applicative development in various automation fields, including the commissioning of machines. The most common applications CMZ operates in are: packaging, beverage, weighing, converting, ceramics, wood, metal sheet, glass, photovoltaic.
- Programming in PC environment, for tools and applicative development.

Considering our history and ability in acquiring new skills, we can only feel like Innovators. We believe in Innovation as a must and we invest 30% of our resources in R&D.

We also believe in building partnerships, as opportunity for growing and enhancing our product range.



BEVERAGE



CAN 3 DRIVES ON 1 NETWORK, MAKE AN APPLICATION?



A medium-complex application is a challenge in terms of technology innovation and costs demolition.

According to this principle, we developed a labeling machine where 3 drives, based on our stepless technology, are able to manage all the machine without the controller.

ISD is an integrated system consisting of two phases asynchronous stepper motor with closed loop, full digital servo drive, encoder and fieldbus.

Thanks to the programmability, the last new feature of our product, the drives, acquiring quite all the inputs, manage all the machine cycle.

The structure of the machine, a high speed labeling machine described in Figure 1, has:

- an HMI with can port as CANopen Master
- three motors with integrated drive: a winder ISD, an applicator ISD, an unwinder ISD
- CANopen connections
- incremental encoder connected to the applicator ISD.

The winder ISD, through two photocells, controls that the labels coil is able to do always the particular “ meander” path of the machine, increasing or decreasing the speed to allow the applicator to always have labels to apply.

The applicator, acquiring the encoder of the rotating section and the photocell that attests the bottles presence, is the heart of the machine cycle, because it manages the application of the adhesive labels with a cams movement.

At the end, the unwinder ISD recovers the paper support belt of the labels, wrapping it again.

Maximum production capacity is 100.000 labels per hour with 60-mm labels.

The most important points of this solution are the using of stepless technology and the drive programmability.

Stepless technology allows to use asynchronous two phase brushless motors getting performances similar to the brushless motors ones. The intrinsic problems of the stepper motor are deleted (noising, warming, step loss).

Thanks to the drive programmability, that is in IEC61131 environment, using structured-text language, the centralized controller normally present in such application is substituted by a simple terminal with less cost, in fact the management of the motors is committed to the internal software of the applicator.

Besides, the integration between the software and the drive, allows that the machine events should be managed faster than you can have in a centralized solution.

Figure 1

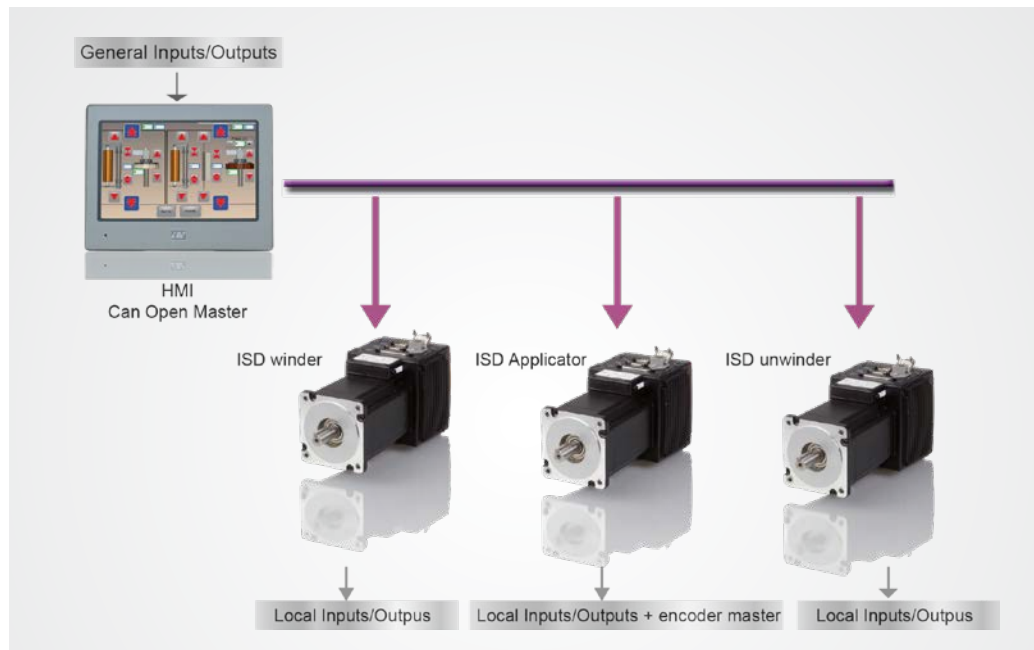

PHARMACEUTICAL



AUTOMATION FOR ASEPTIC PROCESSING

CMZ extends its automation solutions also to the packaging for pharmaceutical industry ensuring safety, precision, speed.



In the pharmaceutical and cosmetics industry, *safety, precision* and *speed* are primary requirements for the designing of a machine.

To reach such an important goal, i-Dositecno company, based in Mataró (Barcelona, Spain) and specialized in the design, construction and sale of packaging machines dedicated to

these industries for the last 15 years, has chosen CMZ skills for the development of its new machines of the innovative XI series, designed to satisfy the needs of aseptic packaging.

For this new project, i-Dositecno has availed of the consulting and technical guidance of CMZ's Spanish integrator, Intra Automation (Valencia, Spain), using CMZ technology for

the automation part. Intra Automation and CMZ have been collaborating for about 40 years on the development of automation projects, in particular in the packaging field, proposing solutions based on a specific and multi-year experience in the motion control and availing of important collaborations with many customers.

XI SERIES Technical specifications

With regards to the hardware, the intelligence of this machine is represented by CMZ FCT300 controller. The choice of this controller has been made while researching the perfect balance between power, flexibility, programming versatility and price.

The CODESYS developing environment and the IEC61131 programming standard make this system an open solution for a quick communication between the devices in which the software developing times are drastically reduced, allowing the reuse of part of the code for future applications.

The standard library for the electric cams management (ECAM) allows to reduce the development and installation of the machine.

As operator interface, the machine is provided with a 10 inches terminal panel, connected to the controller in Ethernet. The terminal allows to visualize, modify and re-configure the machine, to manage the alarm history, the weights register, the production, etc.

For the machine movements from 8 to 14 IBD series drives are provided (according to the machine series) always produced by CMZ, connected to the controller through the EtherCAT fieldbus. EtherCAT represents a standard among the real time fieldbus and allows the interconnection real-time of all the machine devices, including the sophisticated weight control system.

The IBD are servo-drivers with integrated electronics, allowing to save space in the electrical panel and a considerable wiring reduction. The IBDs even have the advantage to be provided of an absolute encoder, allowing not to have the need to execute the homing procedure in case of voltage loss.

The movement of these servomotors is executed in electronic cam, in which all the axes follow a virtual master. This allows to reach a high production speed and flexible movements in the format that has to be made. In order to do this, CMZ's electronic cam library is used because of its flexibility, user-friendliness and power.

Functional characteristics

The XI series of i-Dositecno is represented by machines which are completely servo-motorized, facilitating a quick format switch and a lower particle generation thanks to the reduction of the mechanical transmission elements. These systems allow to memorize in the recipe each machine axis position, simplifying this way the usability.

One of the most important feature of XI series is its speed, obtaining productions of 9000 pieces/hour and a dose amount up to 500 ml.

Precision is another fundamental feature of these machines, incorporating the IPC (Inline Process Control) with 100% of the weight control, container tare and the net weight. It let the customer have an exhaustive control of the required dosing and a reject of the bags with out-of-range weight.

These new machines are also provided with a control software for CFR21 part11 according to the FDA regulations, for the good control and traceability of the dosed products. Furthermore, the dosing through ceramic rotating piston with CIP/SIP integrated system avoids the need for removing pistons for the cleaning.

As shown in the technical specifications, the machines are developed by using best-performing and durable materials. They are made in all parts with stainless steel and high-quality plastic materials, like the PEEK, which allows to work with phials that maintain the sterilization process temperature, reducing the fiction and increasing the machine performances.

Why synergies between mechanics and electronics are important

The excellent results obtained in the engineering of a project like the XI series are a clear example of the importance of synergies between mechanics and electronics.

This has been possible thanks to the know-how of CMZ and Intra Automation, added to the technical capabilities and innovative spirit of a factory as i-Dositecno and the determined promotion of the open platform.

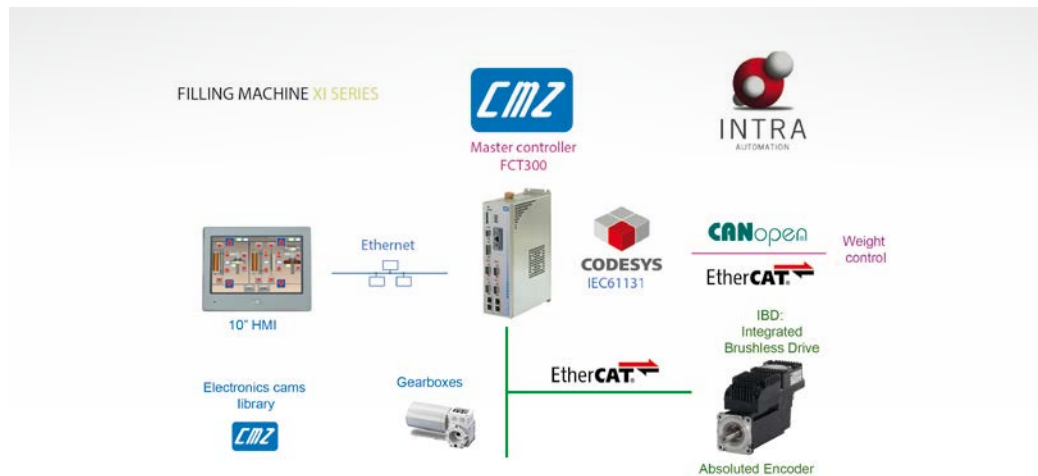

MOTION CONTROL AND TRAJECTORIES GENERATION IN CMZ INTEGRATED ENVIRONMENT



For over 40 years CMZ Sistemi Elettronici has been designing and making programmable controllers for industrial automation and, since then, applies the PLC solution to all the application types, in particular to the motion control. This philosophy has always proven to be successful for the standard controllers of old series.

The natural evolution of this approach has led to the realization of a new standard controllers family, the FCT line, programmable in IEC61131, providing the AWL language and, in addition, three graphical and one computational languages. The use of this powerful tool has even allowed the evolution to the axes trajectory generation mode.

Next to the classical “library” approach (cams, interpolation, flying shear, etc.), with this new environment the user has

the possibility to develop, easily, his own motion laws by constructing his own libraries or special applications.

The axis management program, in addition to the standard mode, provides a custom mode that can be easily activated through a specific Function Block, that allows to generate the trajectories from a normal IEC cyclic task.

The Figure 1 describes the Axu_CustomTrajectory Function Block (of the CMZ standard library) that on the positive edge of the Enable signal activates the custom mode; then, at every cycle, the block sends to the selected axis the position, speed and acceleration that are calculated by the TrajectoryCalculation Function Block, prepared by the user that usually uses the ST language. Between the task cycles, the trajectory is interpolated with a polynomial law.

In the frequent case in which the motion depends on a master reference (a real or virtual axis), it is more convenient to use a slightly different scheme (Figure 2) where the TrajectoryCalculation block2 does not calculate the speed and acceleration of the slave axis but the first derivative (DPos) and second derivative (DDPos) of the position relative to the master.

The FB Axu_CustomTrajectoryMaster then converts these derivatives into speed and acceleration. The general layout of the axis management program in the CMZ controllers is described in Figure 3.

By combining the use of standard and custom libraries, complex applications have been developed in various sectors of industrial automation.

Figure 1

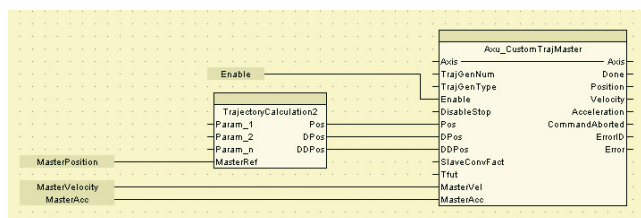
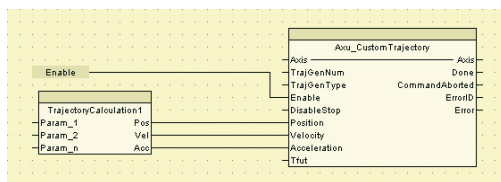

Figure 2

Figure 3

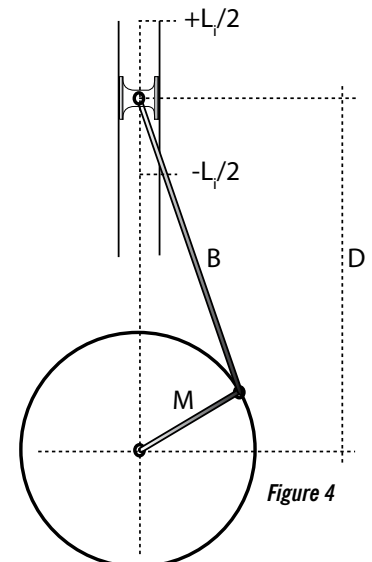
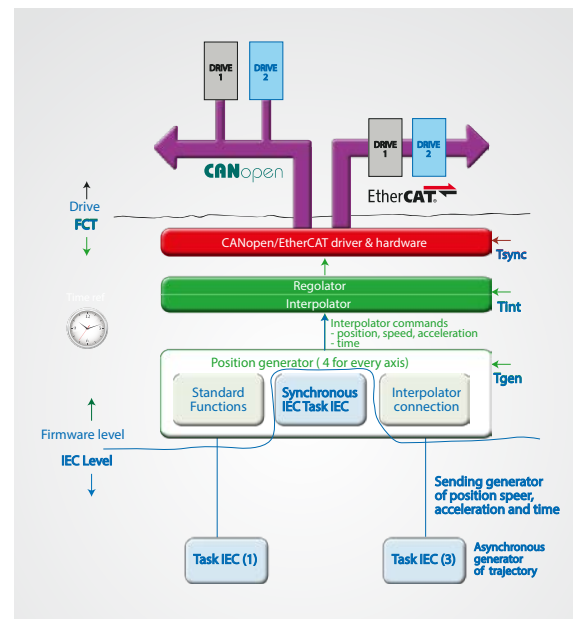

Figure 4

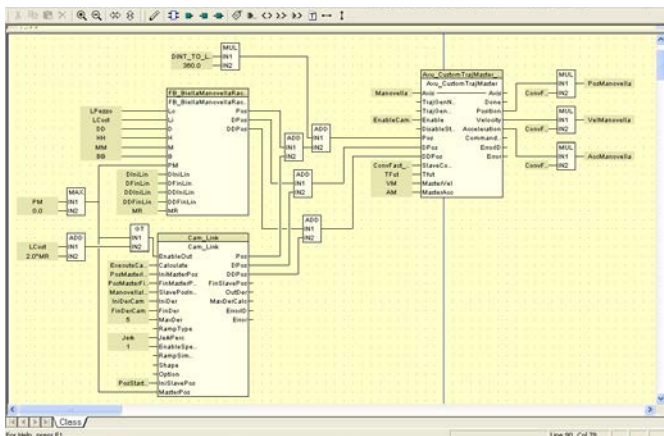

Figure 5

As an example we show a particular application: the linearization of the foot movement of a crank-conrod mechanism (Figure 4), where with linearization we mean the achievement of a movement with constant speed in a certain interval, that is, to make sure that the speed of the foot is constant, and connected to the speed of the master, in the length L_i (between $-L_i/2$ and $L_i/2$).

Crank movement is the contribution of two trajectory generators (Figure 5): the first custom block `FB_BiellaManovellaRac` generates the movement of the crank in the tract of linearization, the second block of the libreria (`Cam_Link`) generates the profile of recovery and junction.

Finally, the `Axu_CustomTrjMaster` library function block generates the position, speed, and acceleration of the crank in relation to the speed and acceleration of an axis master.

The Figure 6 shows the trend of the speed of the crank (Red line), the trend of the speed of the skate (Green line), the performance acceleration of the crank (Gray line).

The possibility for the users to build their own libraries greatly reduces software development time. The development environment works in a particularly efficient way as it translates programs written in various IEC61131 languages directly into the machine code of the PowerPC processor of the controller.

The master controller used in such applications belongs to the FCT line that currently consists of 2 models, FCT200 and FCT300. The most powerful model, the FCT300, has,

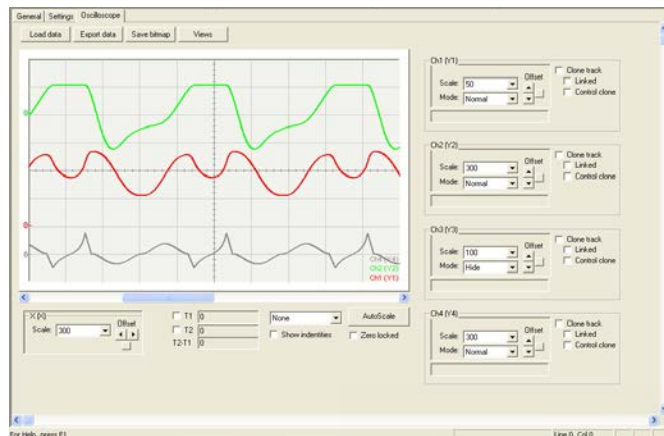

Figure 6

in addition to the common CANopen fieldbus of the smaller brother, also EtherCAT interface and has performance features and resources that put it at the high end of the reference market. The FCT300 is equipped with a Freescale MPC8548 processor that features a 1.333GHz clock with first and second cache.

The controller's communication resources are remarkable: 4 Ethernet 10/100/1000 ports, 4 CAN ports, 1 general purpose communication port (where Profibus, Devicenet, Ethernet IP ect modules can be mounted), 1 RS232 serial port, 1 port serial RS485-RS422. Various protocols have been implemented on these ports, others are executable on request or executable by the customer.

The controllers are also based on a real-time (Precise MQX) operating system with drivers developed by CMZ. On the same hardware platform, it is possible to choose (as an alternative to the 4CONTROL development environment) the CODESYS development environment with the same performance.

CMZ has also developed a full range of products that integrate with FCT line systems: brushless and stepper motors and drives in integrated and stand alone version, CANopen and EtherCAT modules for digital and analog input/output interfaces and terminals.

Such a complete range enables real optimization both of performance and costs, and makes CMZ a very competitive partner in delivering global solutions and services.

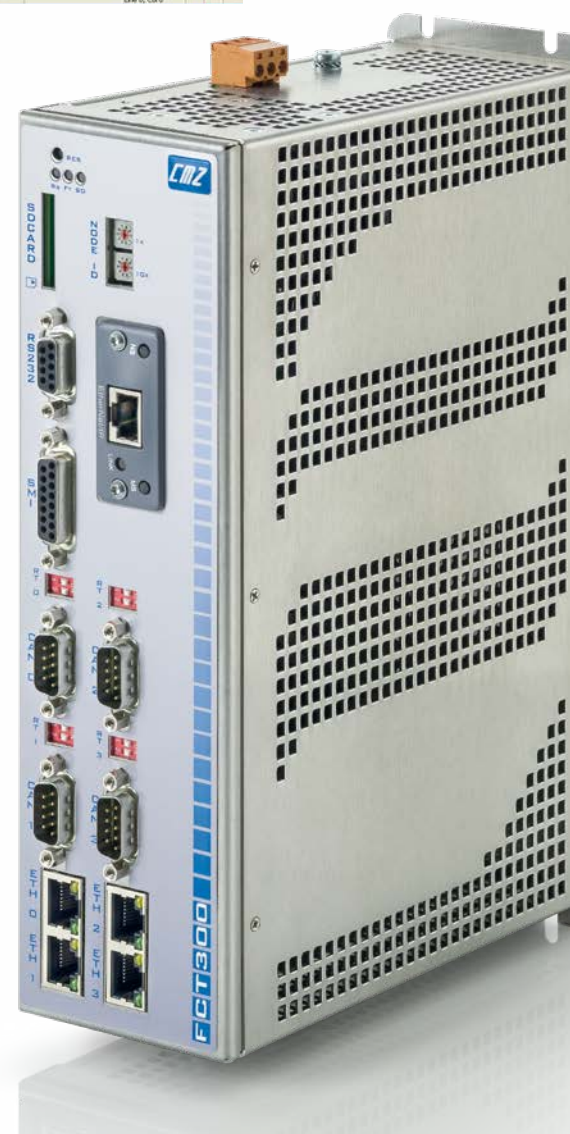

RAILWAY



ELECTRIC MOTORS FOR RAILWAY, ITALIAN TECHNOLOGY ON HIGH SPEED TRAINS

Soga state-of-the-art technology, special electric motors operate also on high speed trains worldwide to supply auxiliary systems on board.

Our top-technology Made in Italy electric motors for high speed trains are specifically engineered to meet the strictly severe requirements of the global rail industry, by powering on board auxiliary drives:

- Braking systems (managed by dedicated air-compressors)
- HVAC equipment (Heating, Ventilation, Air Conditioning)
- Cooling units
- Other auxiliary systems

in accordance with the railway standards including NF F 65-101 and IEC 60349, serving international recognized societies.

They are completely customized asynchronous 3-phase electric motors designed by our R&D department upon on-demand specifications, suitable for inverter and having the following main features:

- Squirrel cage, totally enclosed IP55-IP65, cast-iron end-shields, aluminium housing
- Outputs class H or F, over temperature class B
- Self-ventilated (IC411) or forced-ventilated (IC418)
- Reinforced windings by special treatments (VPI, encapsulation, etc)
- Special shafts materials
- Hybrid bearings
- Highly balanced rotors



- Enhanced saline-mist protection against corrosion up to 1,000 hours
- Quality and Control levels at the highest peak on every single stage of production, contributing to reach full security in people and goods transportation
- Electrical and mechanical layout studied for best efficiency, low energy consumption, simple maintenance, durability. In 3 words: *Reduced Investment Costs* (on the short and long term).

Installed on trains and undergrounds from Europe to Asia, from Australia to Americas, Soga electric motors are important components in connecting people and carry millions of products every day, covering continents and countries.

Our co-operation with the players of rail sector is an achievement which we are extremely proud of, pushing us to never stop innovating by introducing always new technical concepts and solutions advancing the industry of rotating electrical machines.

Full commitment, research, great passion: such a mix makes Soga electromechanical knowledge a leading expression of the best Made in Italy.



RENEWABLES



VARIABLE SPEED, PERMANENT MAGNET GENERATORS FOR ENERGY SPECIAL PROJECTS

Soga Energy Team develops Sogaenergies branded variable speed high-efficiency alternators, for renewables and special applications.

Constant speed alternators represent the most widespread solution for power generation industry, used on generating-sets and engine-driven welders. In constant speed applications (1500 or 3000 RPM depending if coupled to a 2 or 4-pole endothermic engine) the rotor is made of copper electrical windings.

But, rotors can also be made with modules of permanent magnets (Nd-Fe-B): in this last case, the application field switches from 'constant speed' to 'variable speed'.

The Soga Energy Team industrial group is a pioneering leading player worldwide, by manufacturing variable speed permanent magnet generators (PMG) since 2008 with its division SOGAENERGIES. It is focused on the development of new custom-made solutions for renewables and energy special projects requested by highly specialized industries such as wind, hydro, hybrid systems, automotive, military, railway, telecom.

Focusing on PMGs at low RPM, Sogaenergies EV synchronous alternators with power range from 2 kW (EV180 frame size) to 300 kW/AC (EV900) are suitable for many variable speed applications

at low speed (500 max RPM). Important studies have been carried out on applications involving high torque motors or traction motors. EV units are also used on direct-drive wind turbines without gearboxes (Sogaenergies is considered the benchmark within the Italian wind industry).

EV alternators represent a disruptive technology compared to other permanent magnet alternators available in the market. The base of innovation lies in their stator, having a 'naked' patented design. It is not inserted in a housing, as usually happens, but itself is the body of the alternator, and the cooling external fins are part of it.

In this way, the heat dissipation surface is wider, stator losses are drastically reduced, and permanent magnets can work 'cold', determining an extraordinary efficiency increase. EV efficiencies are the best in the market (nominal values up to 96%).

The 'naked' stator also allows a reduction in the components and materials used: less lamination, less copper for the windings, less magnets. The resulting alternators are much lighter than common PMGs (there is up to 50% weight reduction), and much more compact.

Thanks to their compactness and light weight qualities, EV variable speed alternators can give OEMs important economical benefits in development (by allowing the simplification of the design of the final products where they are assembled) and in construction (other components can be smaller and made less expensively, and the final total weight will be reduced).

The alternators also assure more profitability. With EV high-efficiency technology OEMs can always have the best optimized energy production. By reducing their current development and construction costs, OEMs can also obtain higher margins from their future sales.

Besides EV low speed alternators, the Sogaenergies range also includes VS hybrid-technology alternators for medium and high speeds, with powers up to 1 MW.

Soga Energy Team is the partner contributing to success of OEMs in the most different applications.

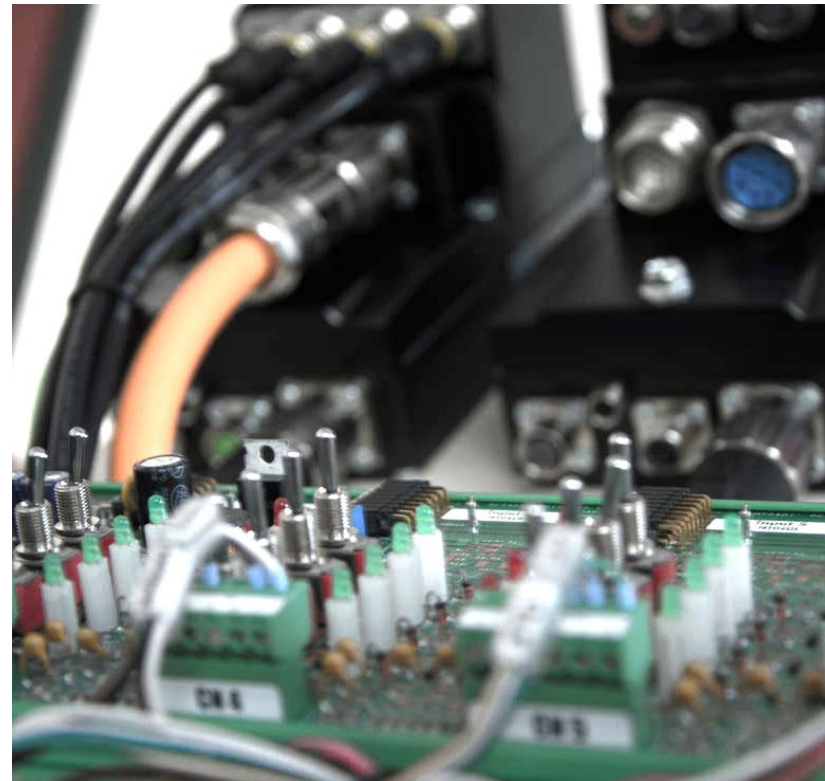
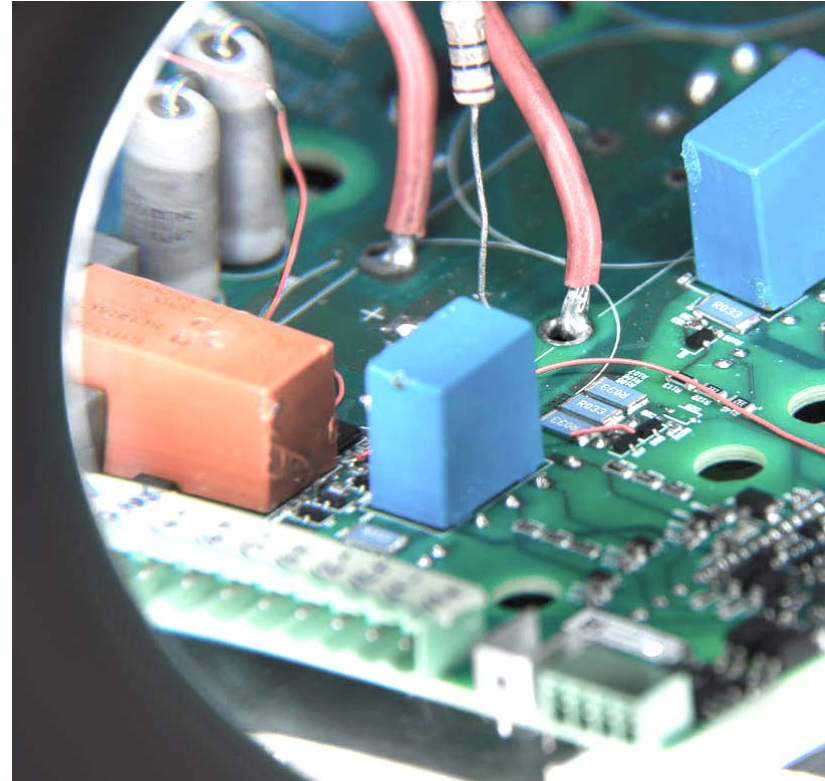
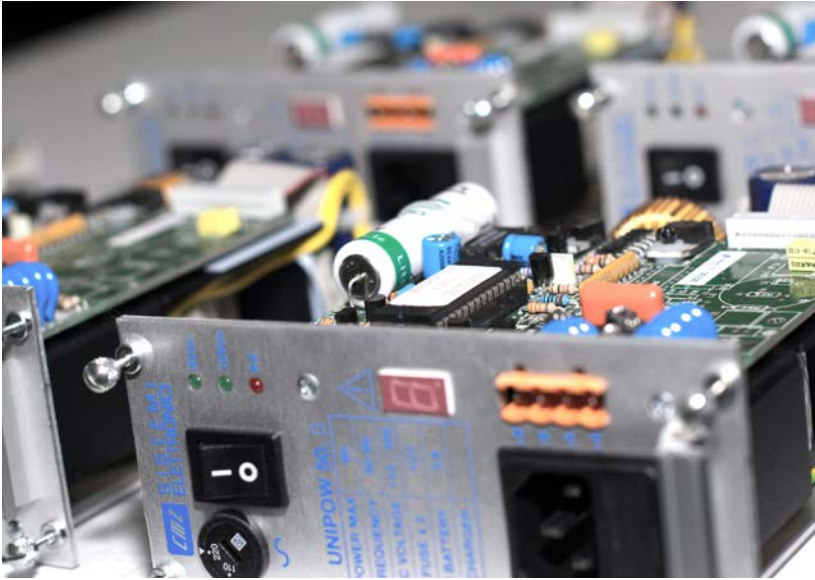

sps ipc drives 

NÜRNBERG 2017
COME AND VISIT US!
HALL 3A, STAND 328

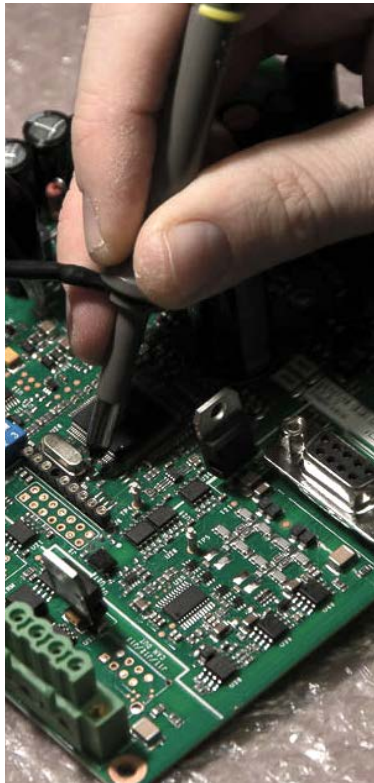
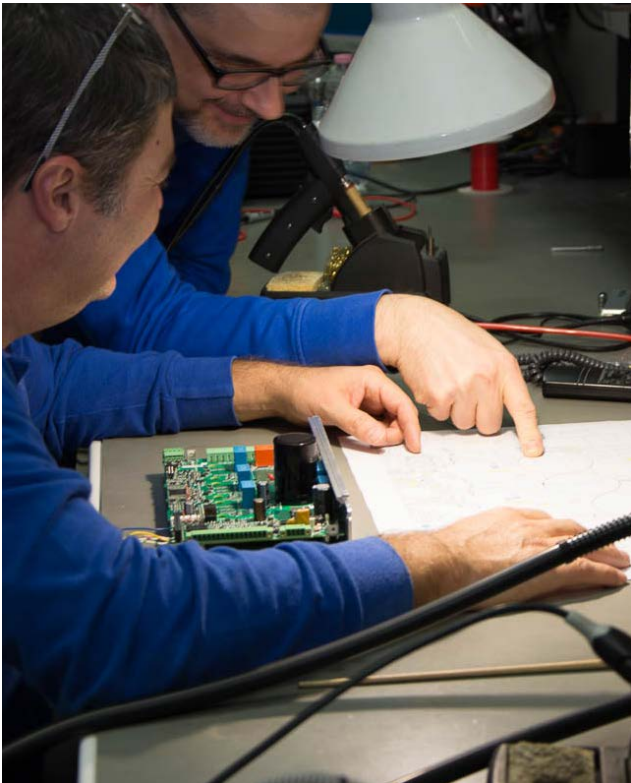
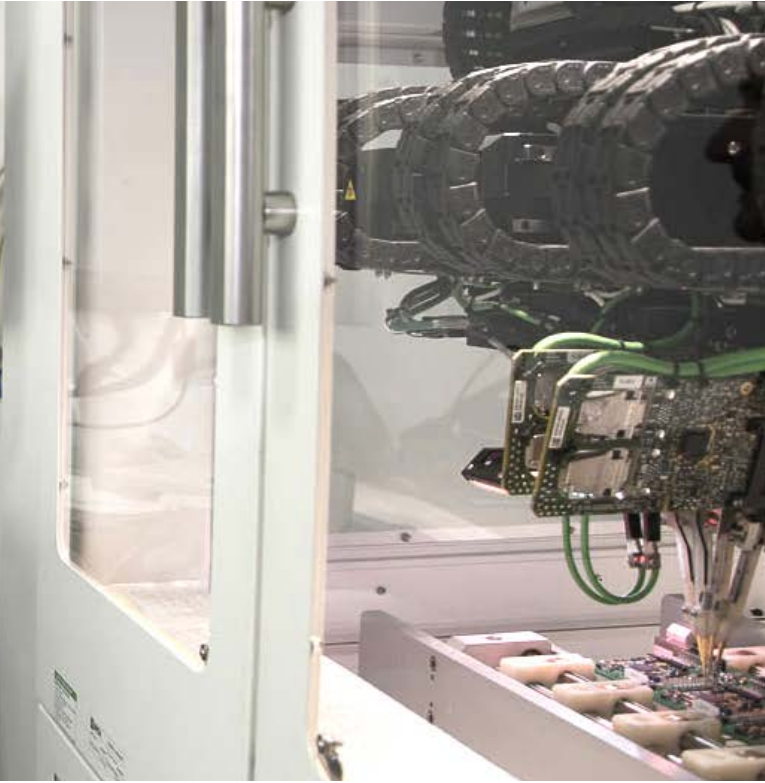



CMZ Sistemi Elettronici S.r.l
 Via dell'Artigianato, 21 • 31050 Vascon (TV) • ITALY
 Ph. +39 0422 447411 • cmz@cmz.it

cmz.it

Soga Energy Team | Soga S.p.A. Headquarter
 Via Della Tecnica, 15 • 36075 Montecchio Maggiore (VI) • ITALY
 Ph. +39 0444 747700 • sales.soga@sogaenergyteam.com

sogaenergyteam.com